

ФАРКОП-ЦЕНТР "СТОЛИЧНЫЙ"

www.farkop-center.ru

Электрика для фаркопов в штатные места. Продажа и установка фаркопов

SUZUKI

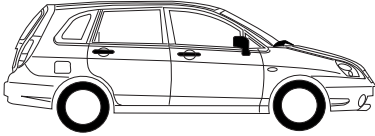

LIANA 05/01 →

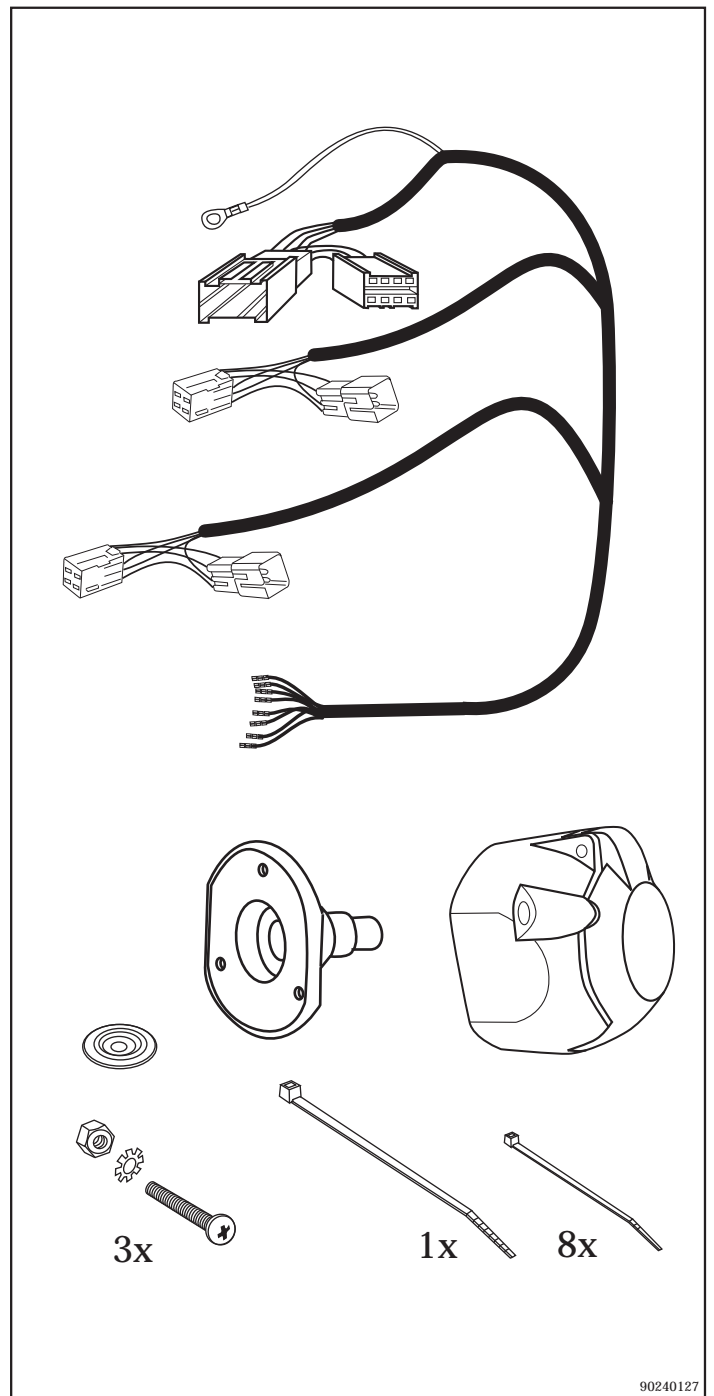
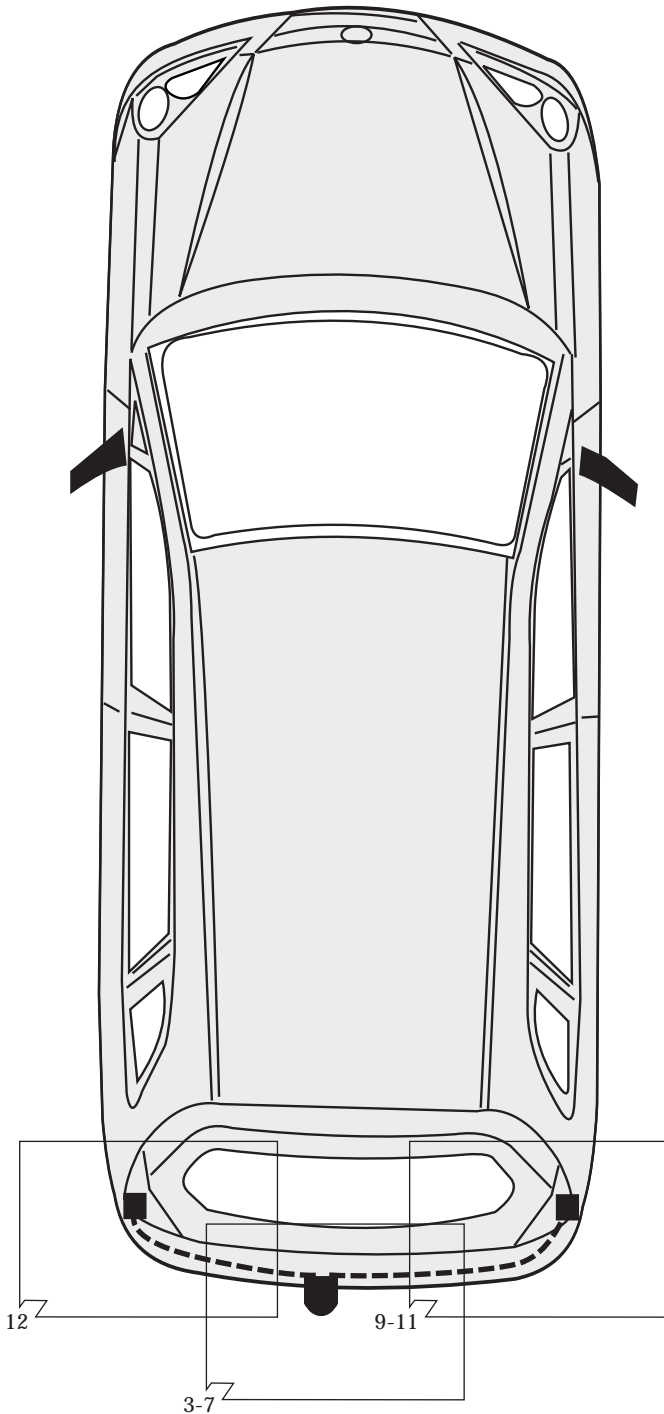

90240127

Änderungen bezüglich Konstruktion, Ausstattung, Farbe sowie Irrtum vorbehalten. Angaben und Abbildungen unverbindlich.

We reserve the right to alter the design, equipment, colour and any errors. All details and illustrations are nonbinding.

Sous réserve de modifications de construction, équipement, couleurs ou erreur. Données et illustrations sous toute réserve.

Con riserva di modifiche relative a costruzione, equipaggiamento, colore, nonché errore. Dati ed illustrazioni non sono vincolanti.

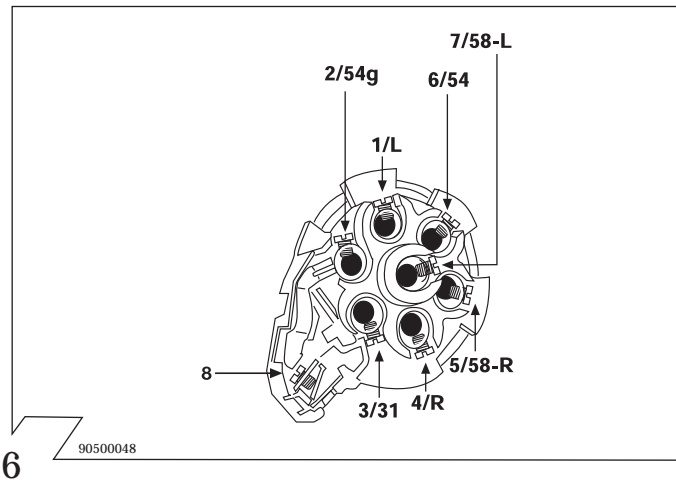
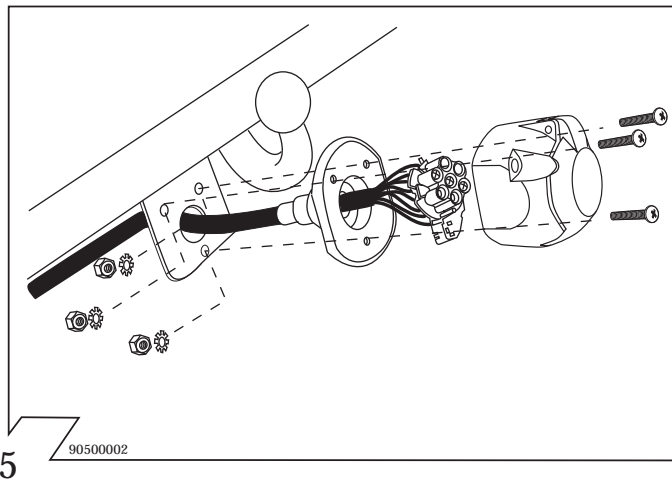
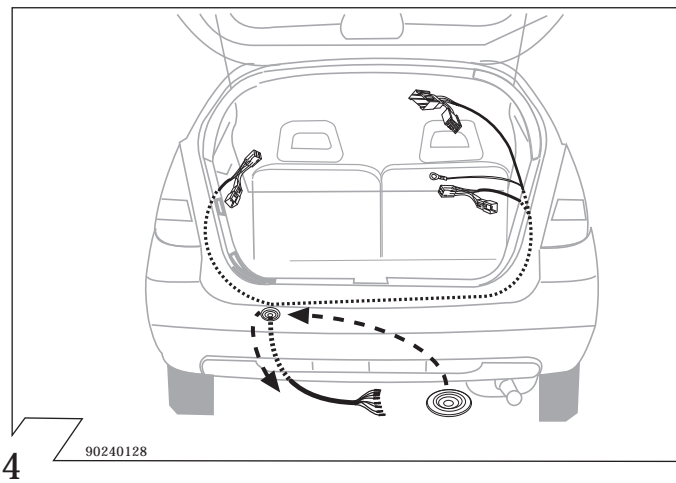
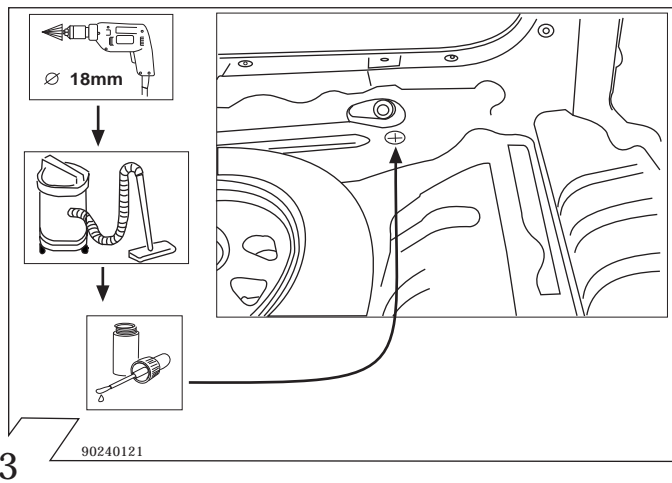
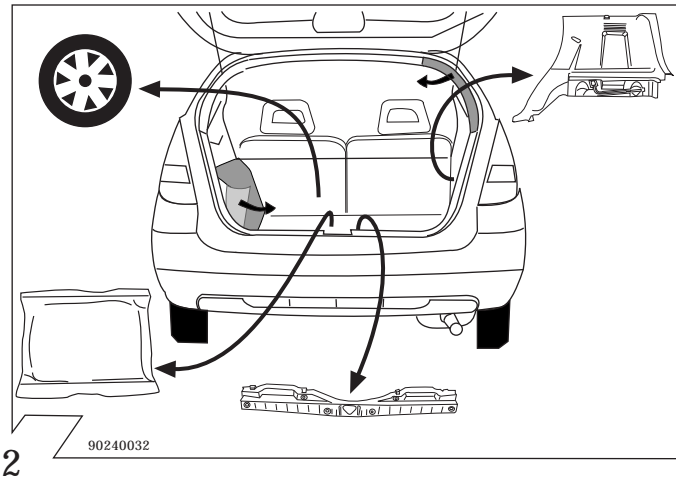
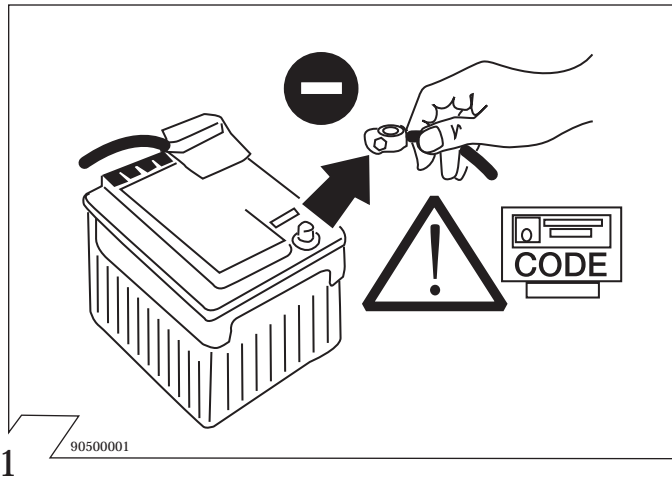

Belegung der Steckdose/Socket Configuration/Correspondance des Contacts de la prise Cavi della presa elettrica sono abbinati

ISO 1724		D	F	GB	I
	1/L	schwarz/weiss	noir/blanc	black/white	nero/bianco
	2	weiss	blanc	white	bianco
	3/31	braun	marron	brown	bruno
	4/R	schwarz/grün	noir/vert	black/green	nero/verde
	5/58-R	grau/rot	gris/rouge	grey/red	grigio/rosso
	6/54	schwarz/rot	noir/rouge	black/red	nero/rosso
	7/58-L	grau/schwarz	gris/noir	grey/black	grigio/nero
	8	schwarz	noir	black	nero

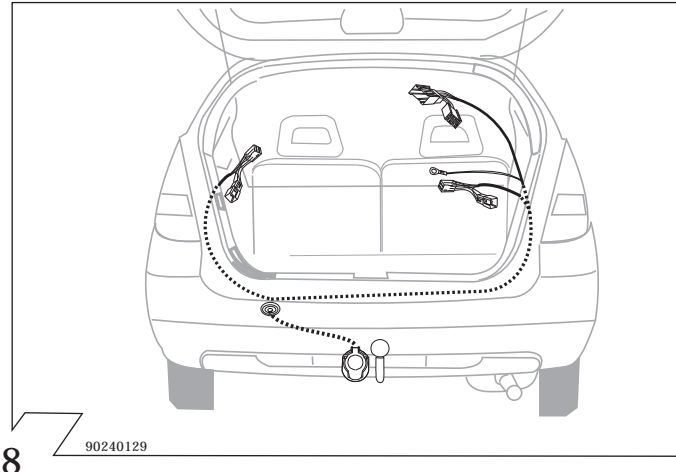

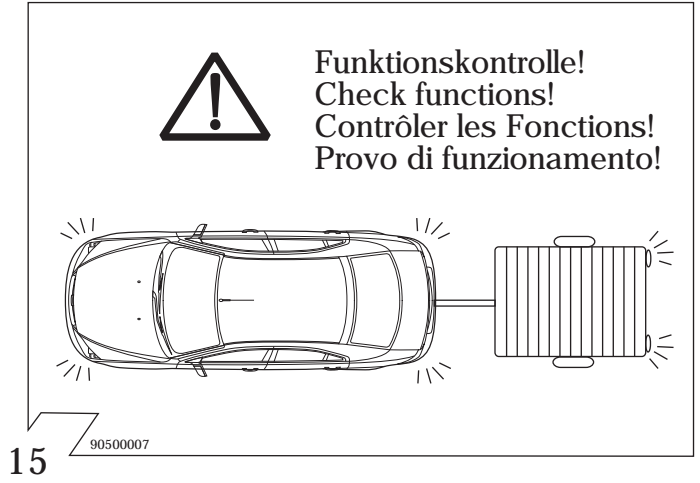
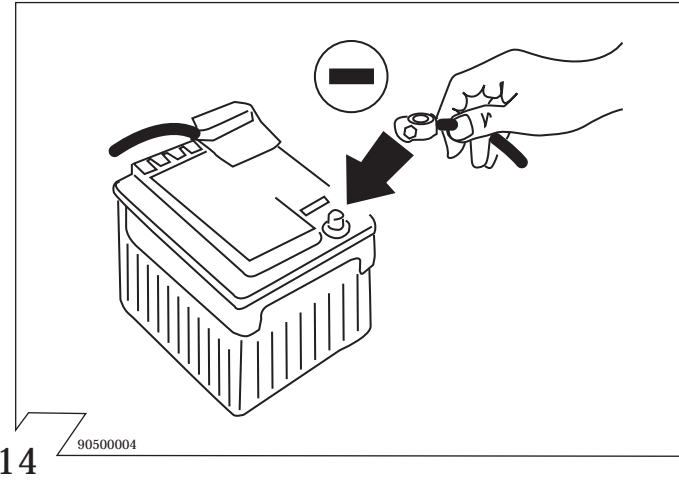
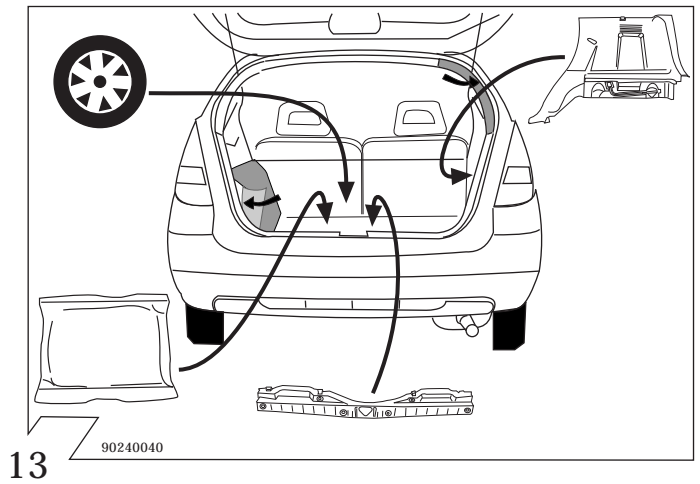
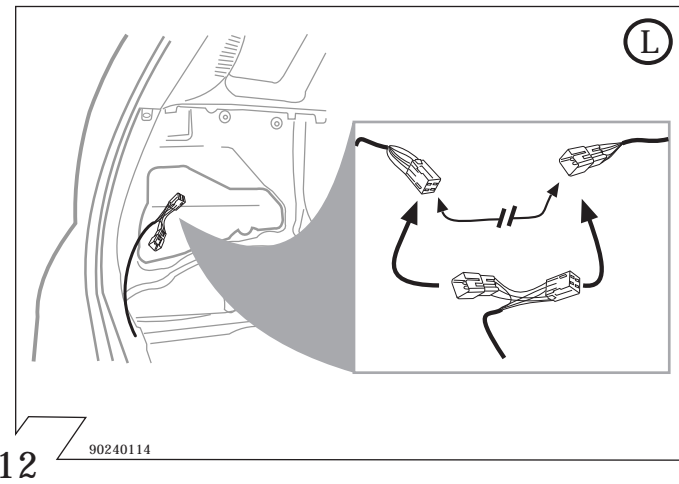
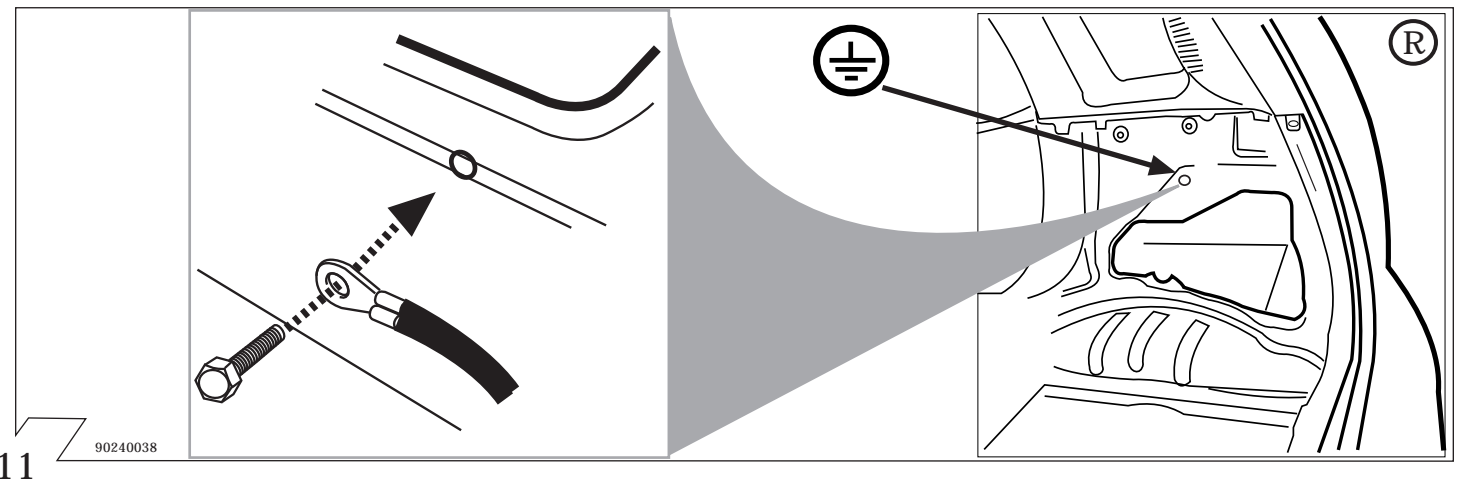
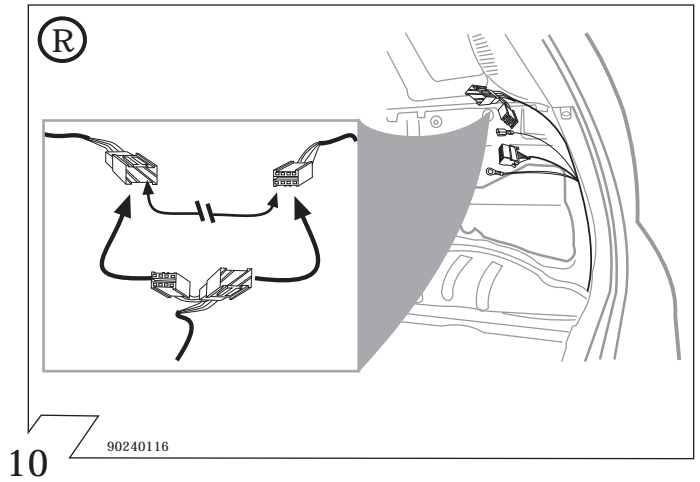
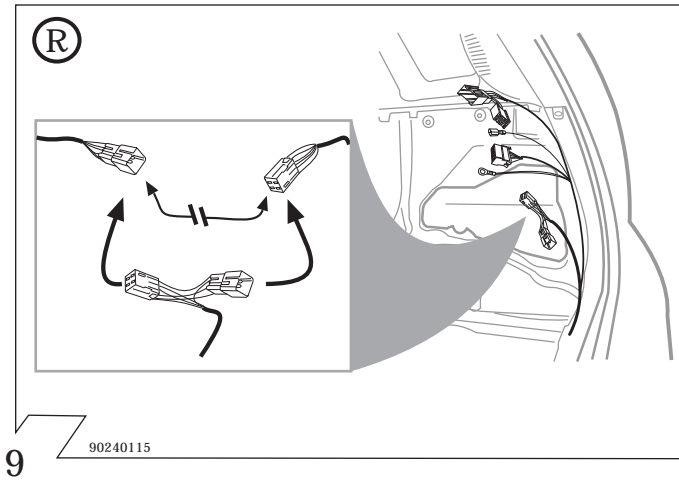

Optional: Adapter socket 62400001

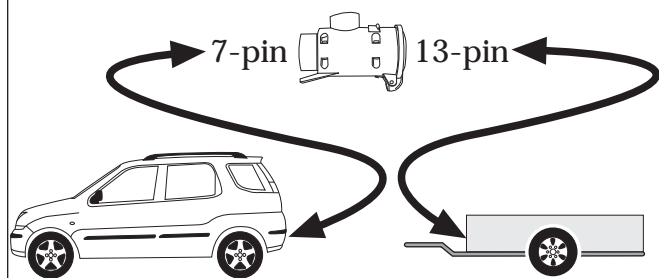

16

90500331

Die Einbauanleitung ist dem Kunden als Betriebsinformation zu übergeben.

Fitting instruction is to be handed to the customer!

La notice de montage doit être remise au client!

Le istruzioni di montaggio devono essere consegnate al cliente!



17

90500006